

Principes de jeux d'enfant



« La prise de risque est un parti à prendre, c'est un formidable moteur pour l'apprentissage enfantin, et un paysage de bois peut être le modus operandi. »

Aire de jeux : Matali Crasset



Stries & compagnies,
Place de la nation, Paris 2020



Extensions de g g rosit , Biennale d'art
contemporain,
Les Ateliers de Rennes 2010



A ro v g tal,
groupe scolaire Nelson
Mandela, Rennes 2017

À HAUTEUR



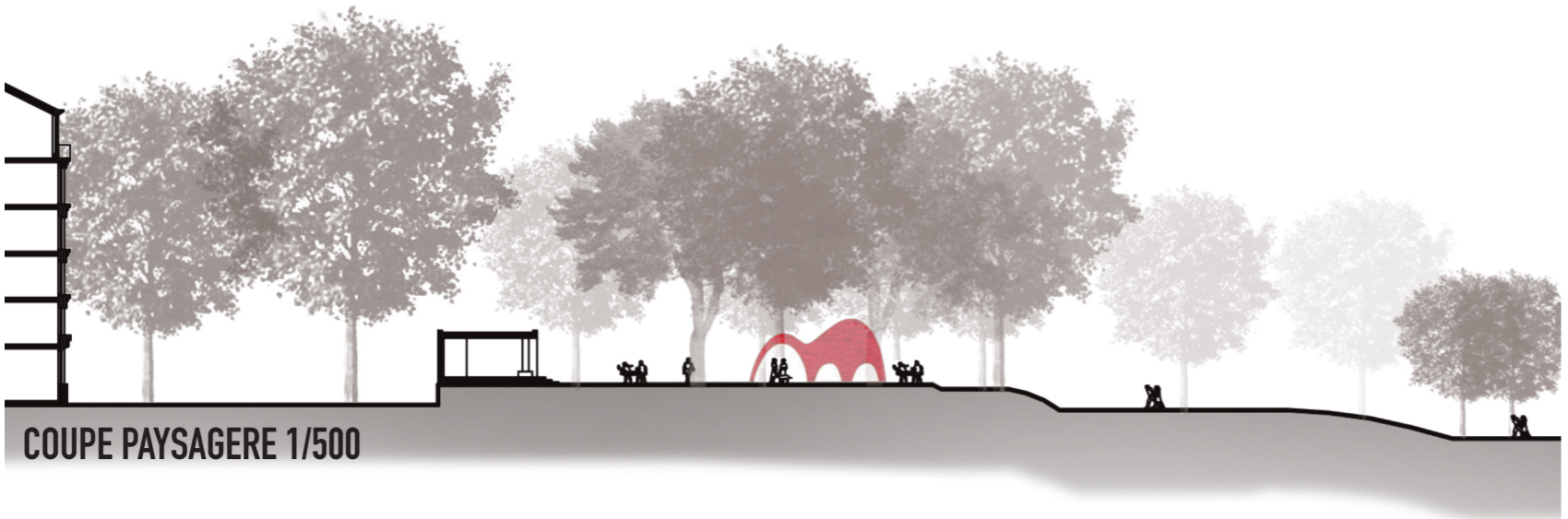

COUPE PAYSAGERE 1/500

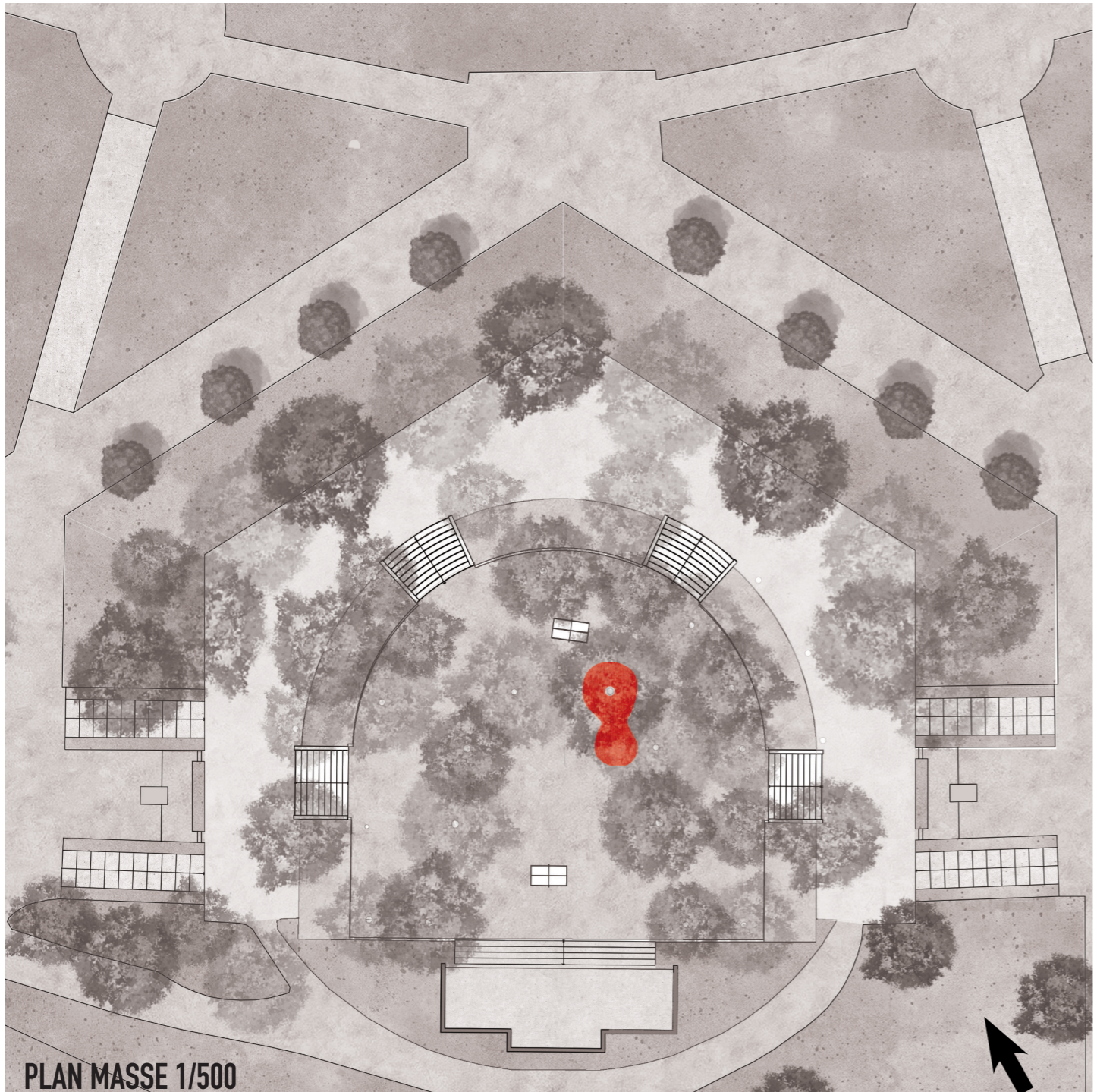
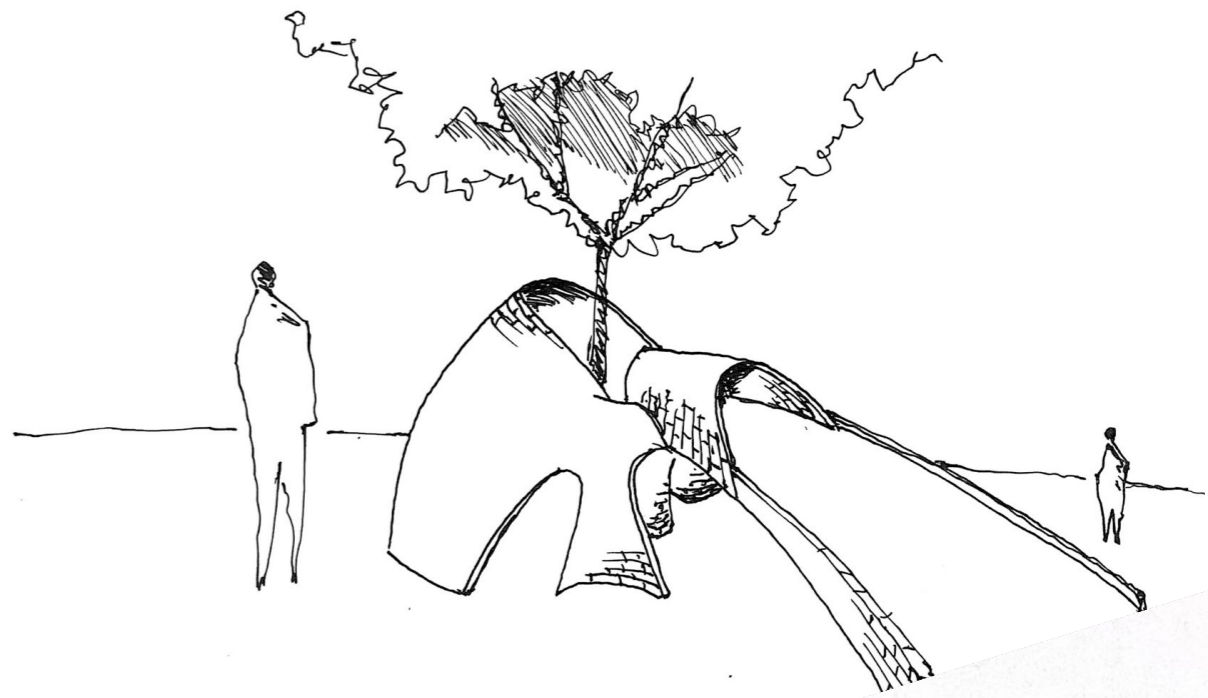

PLAN MASSE 1/500

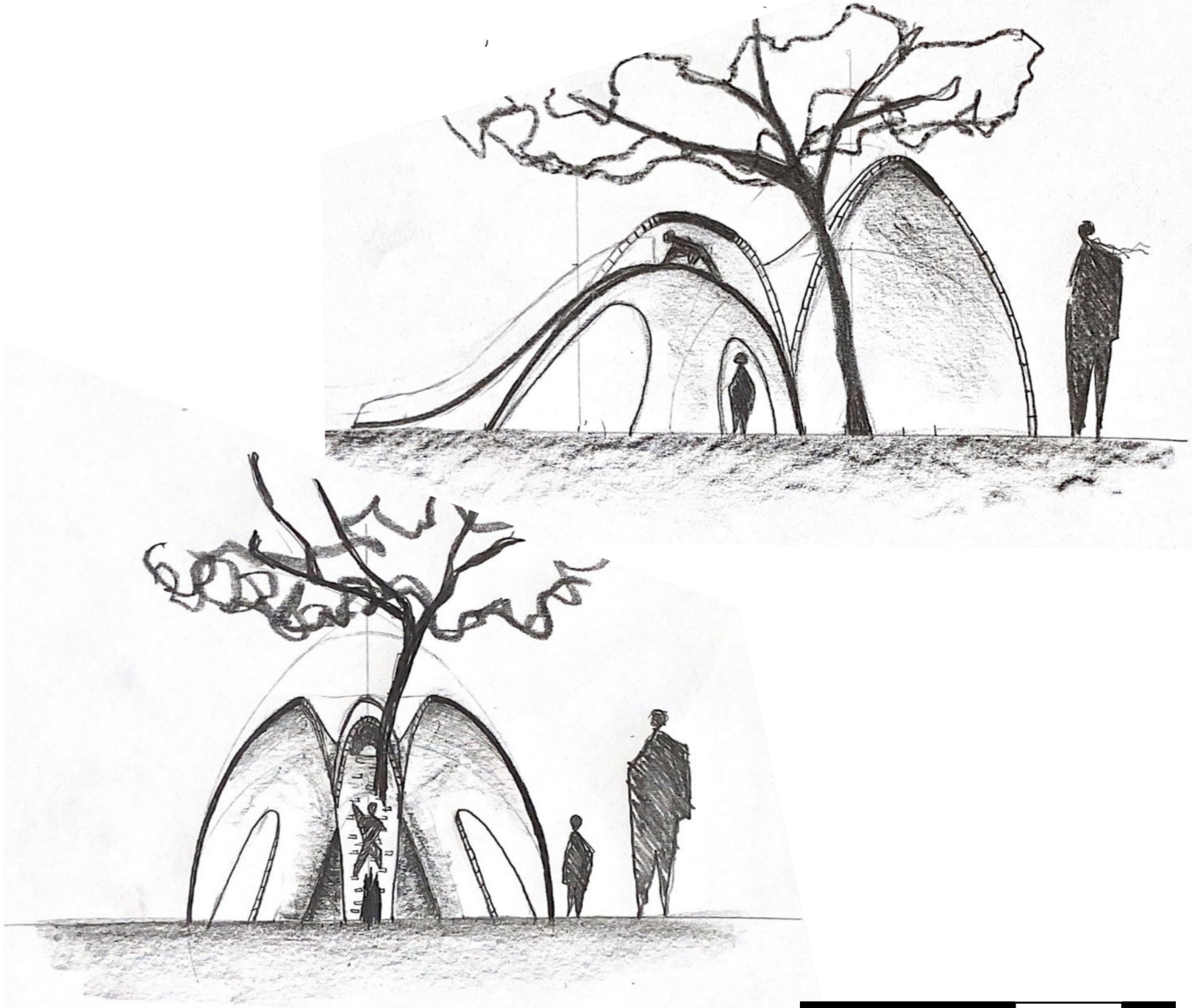

Model 3D

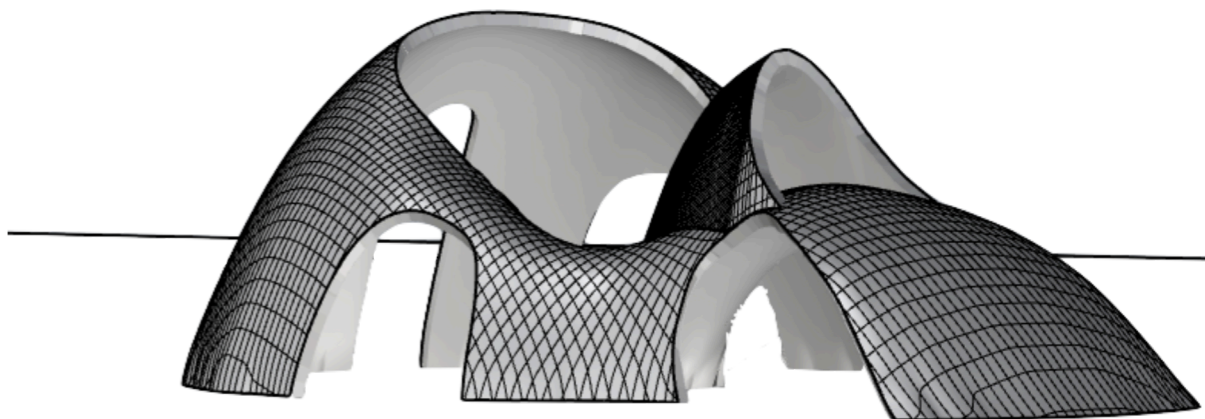
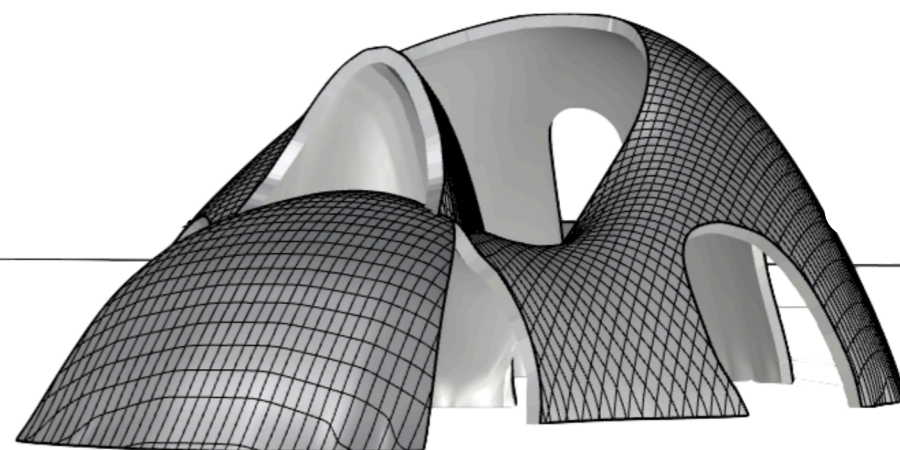
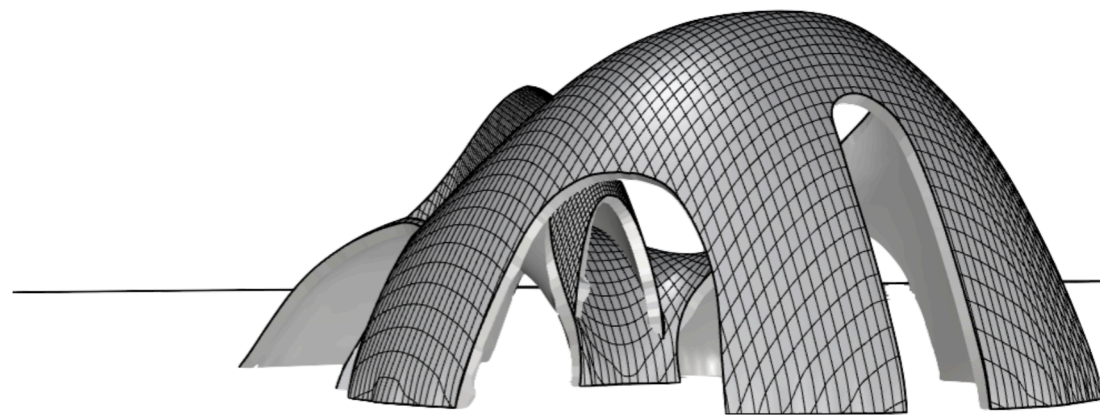
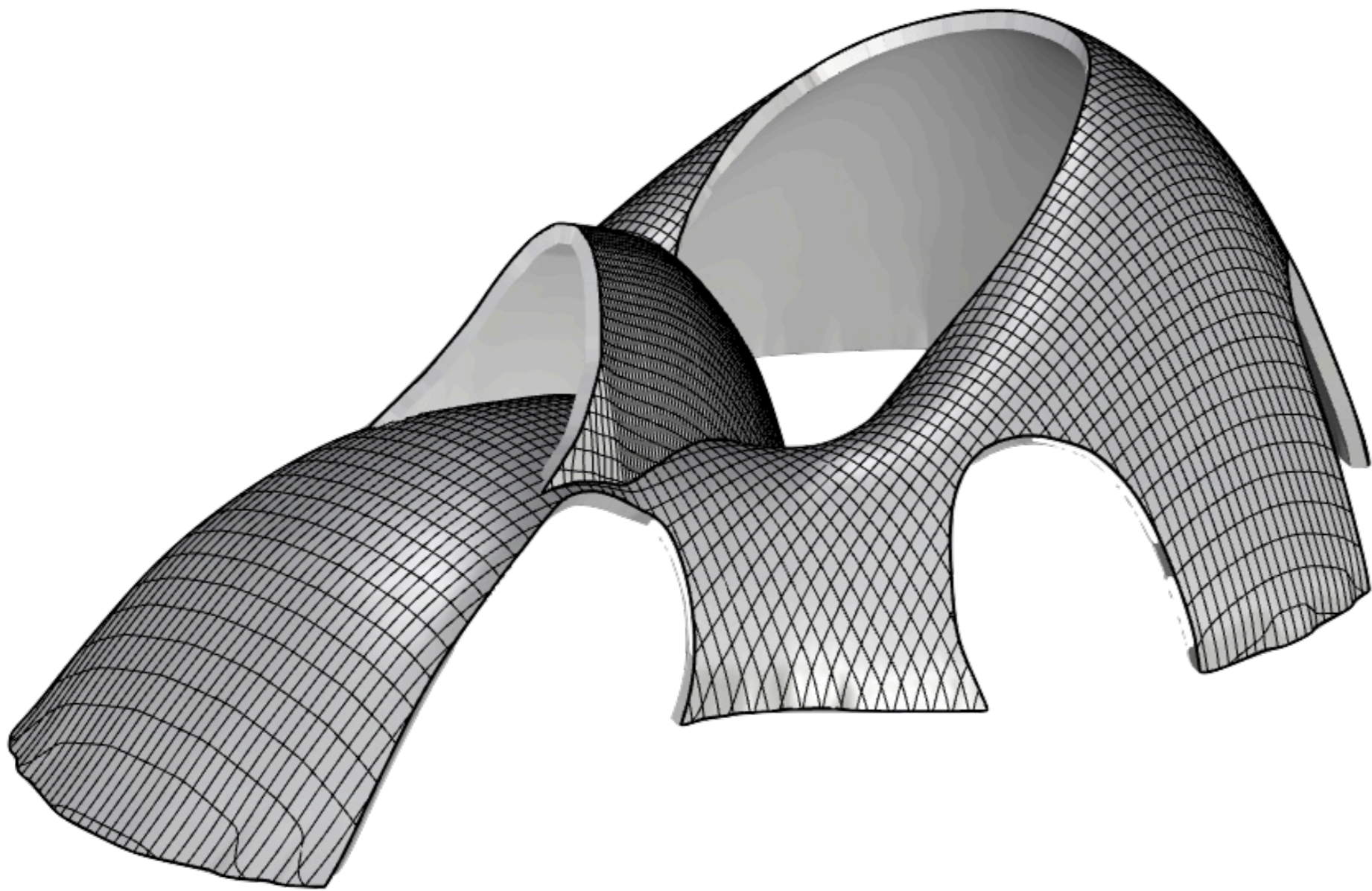

PLAN, COUPES, ÉLÉVATIONS

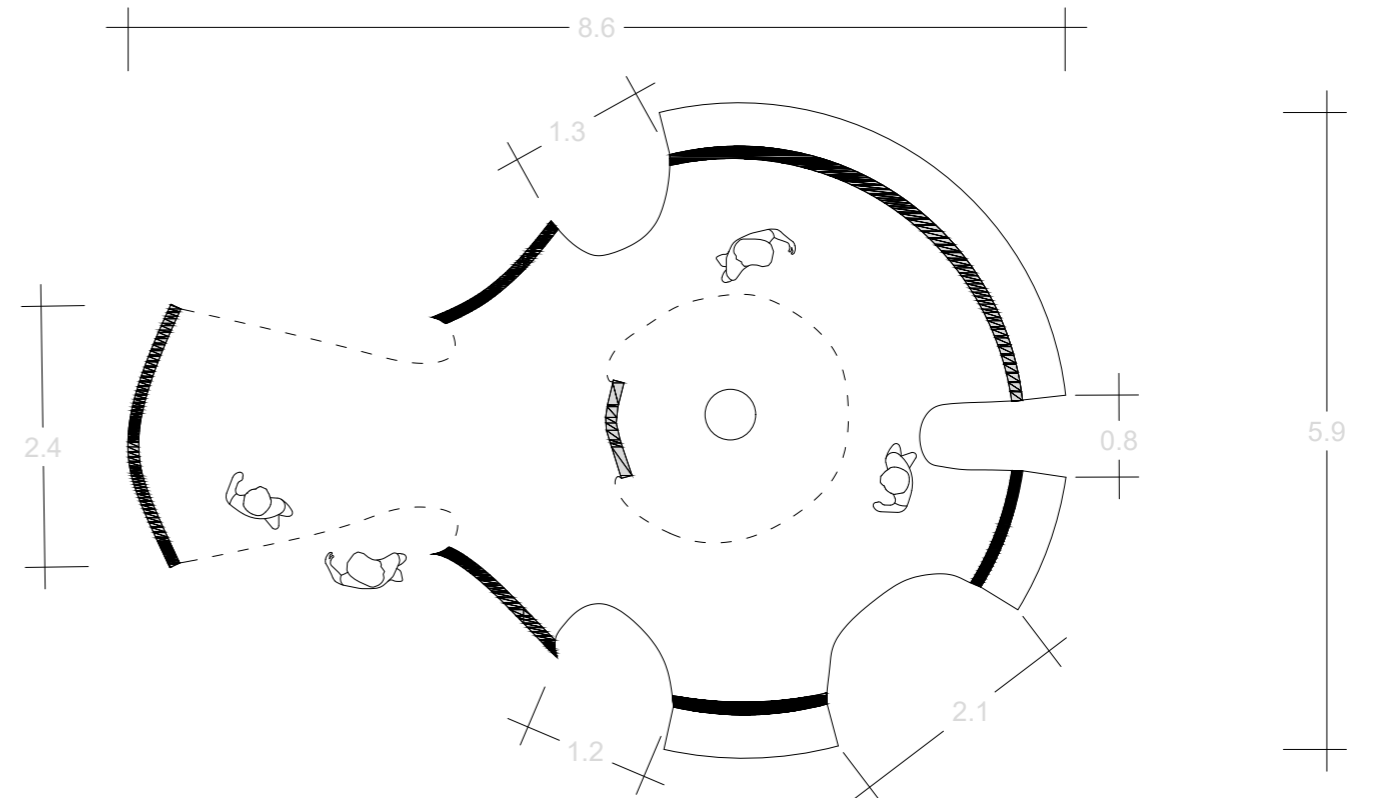
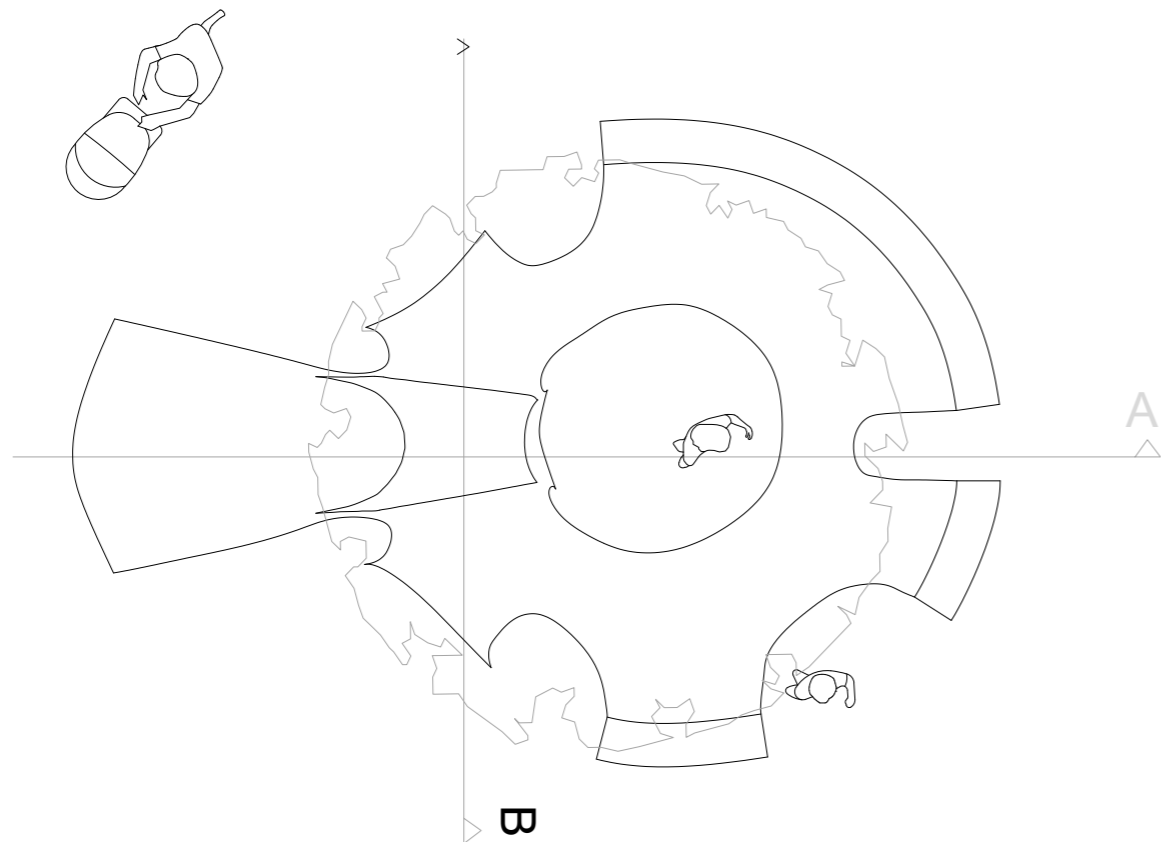
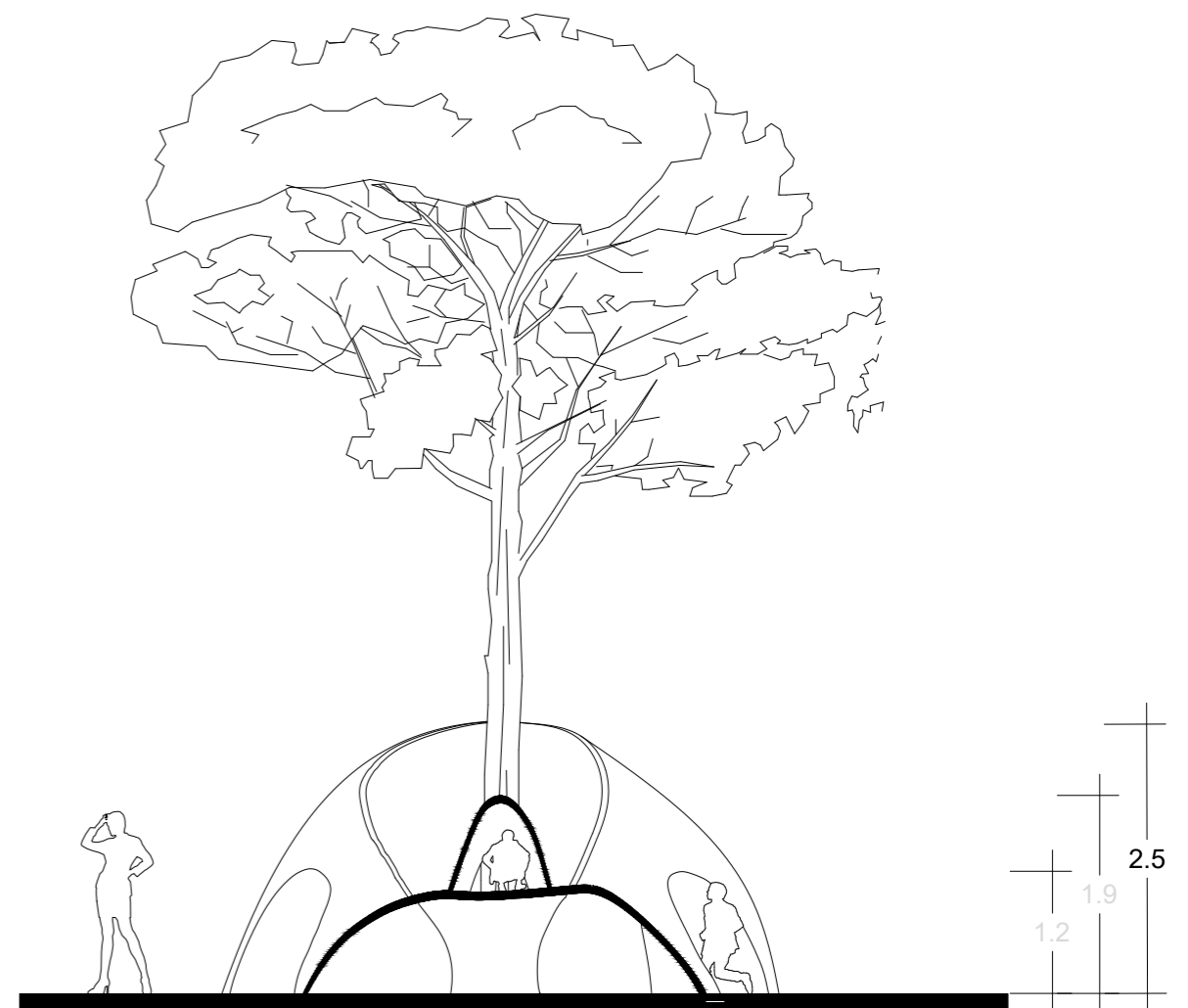

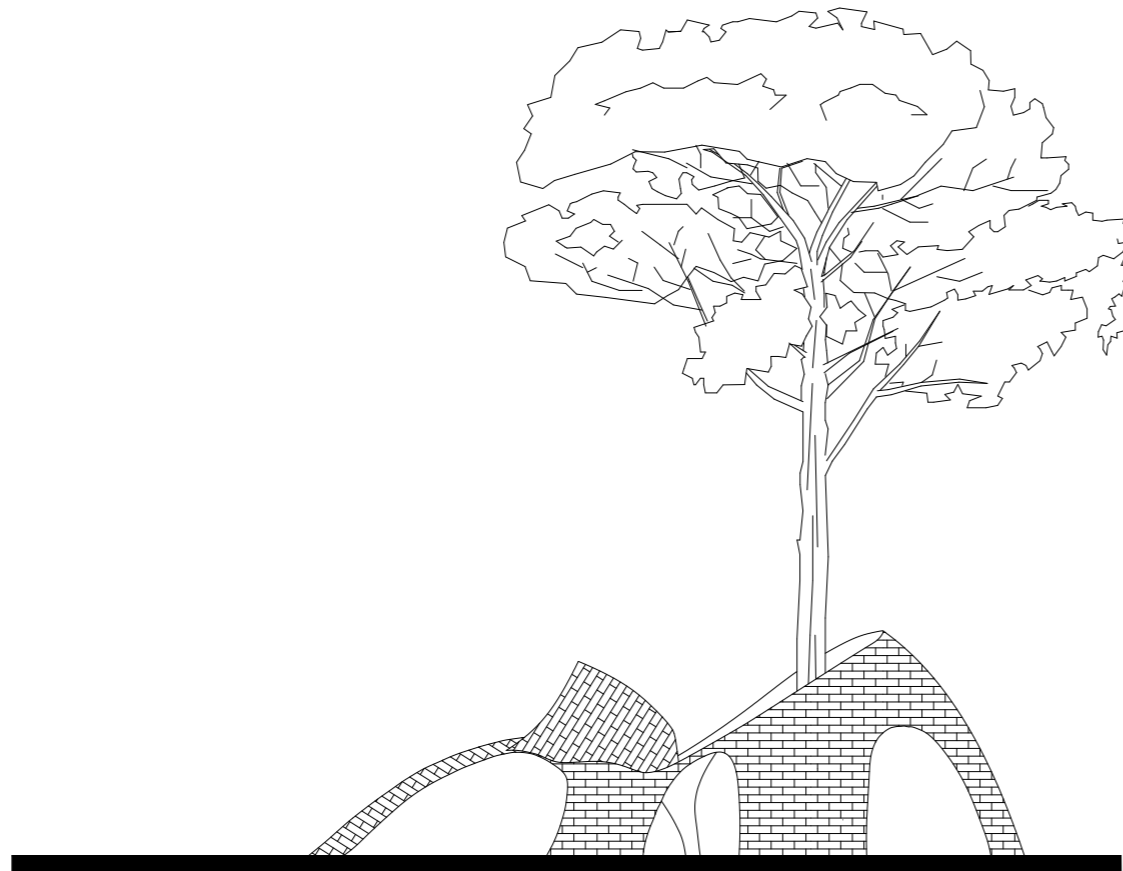

Élévation Est

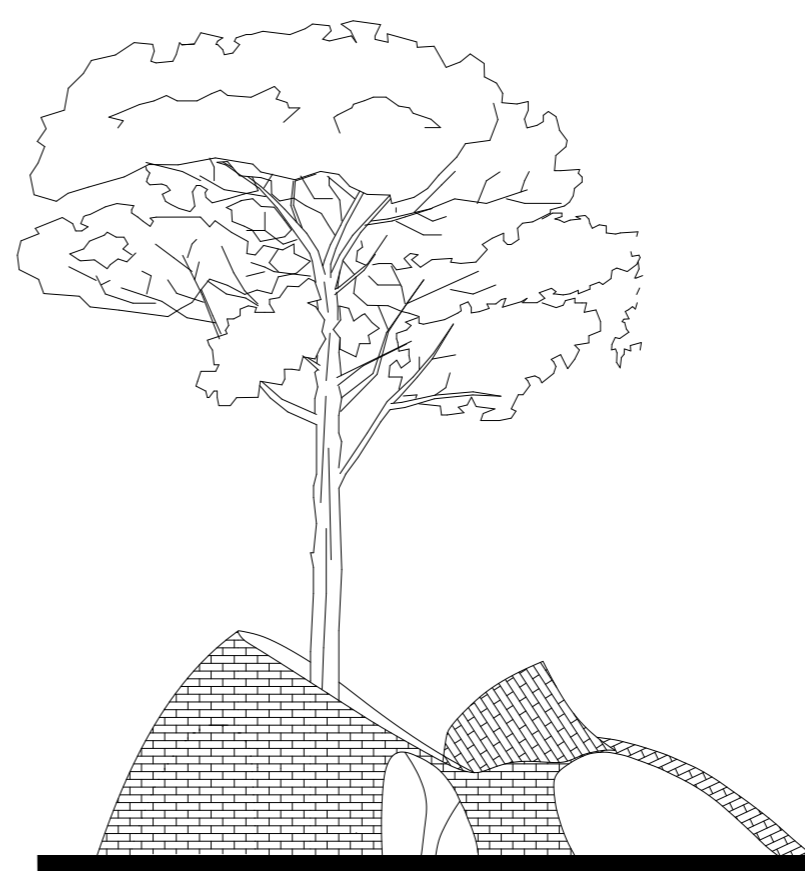

Élévation Ouest

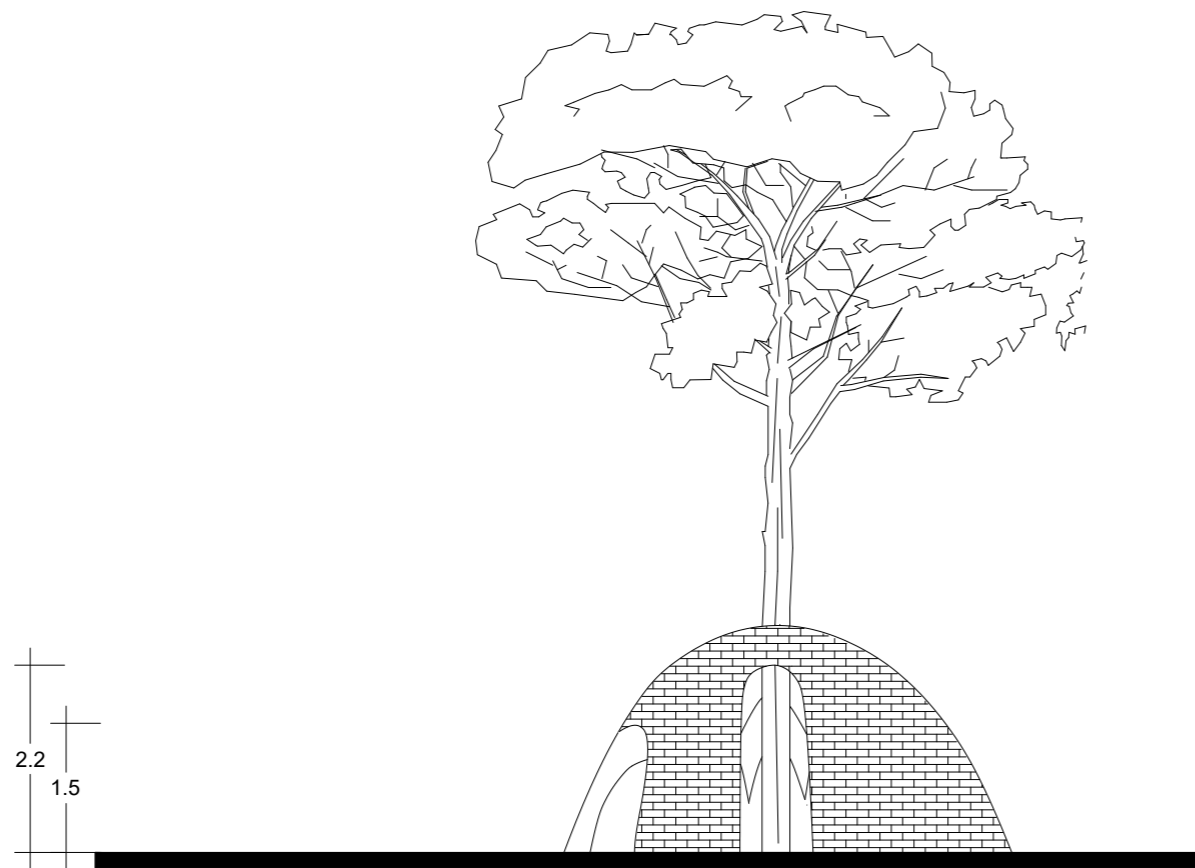
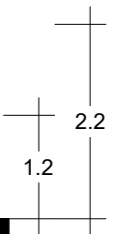

Élévation Nord

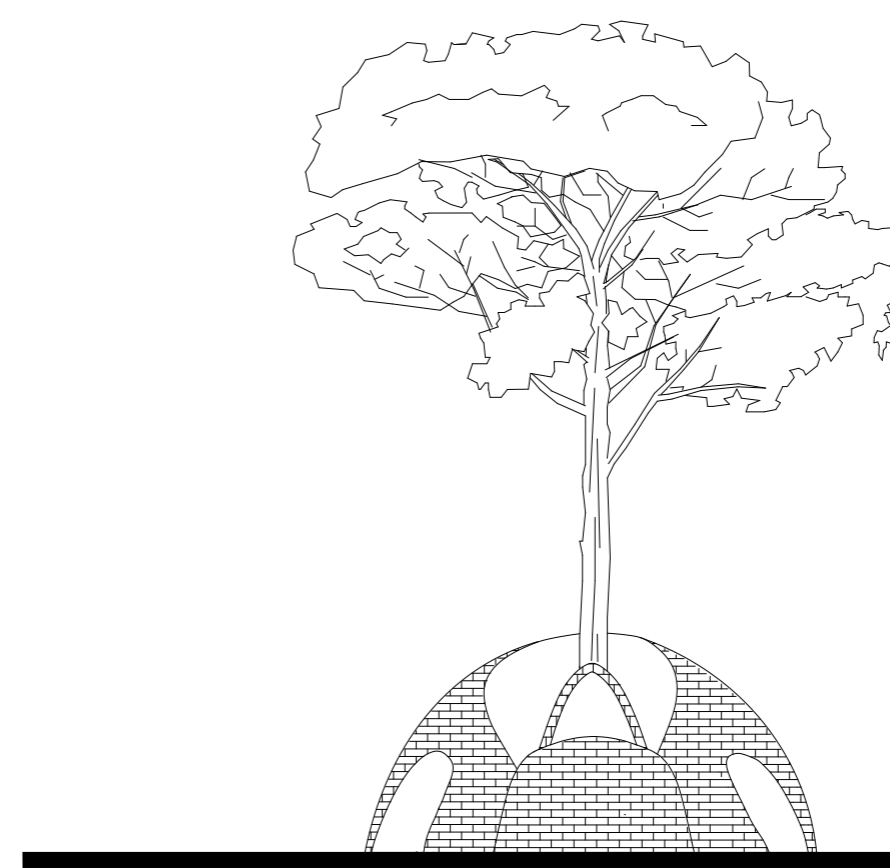

Élévation Sud

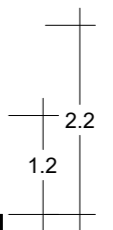
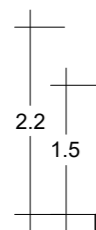

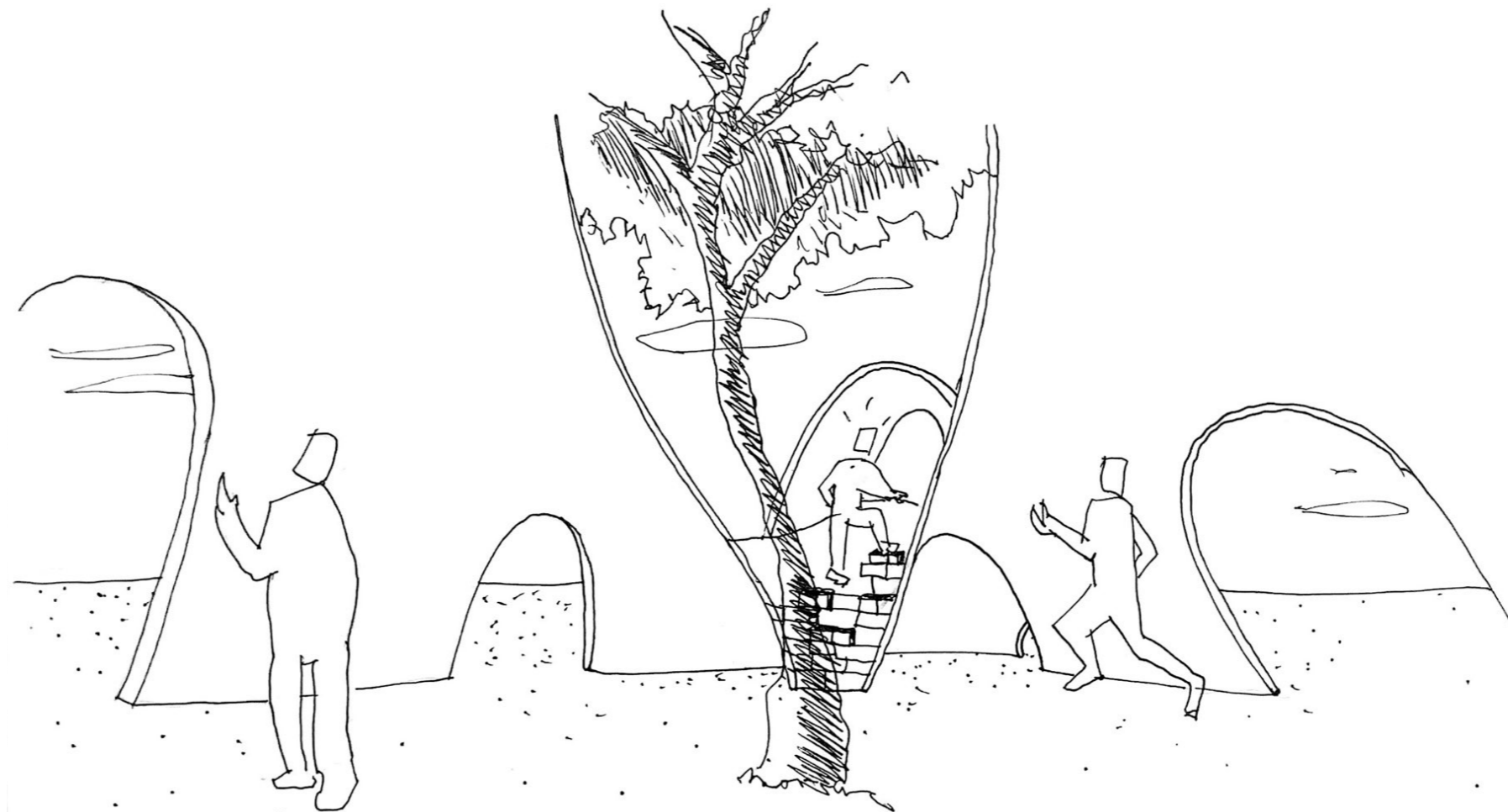
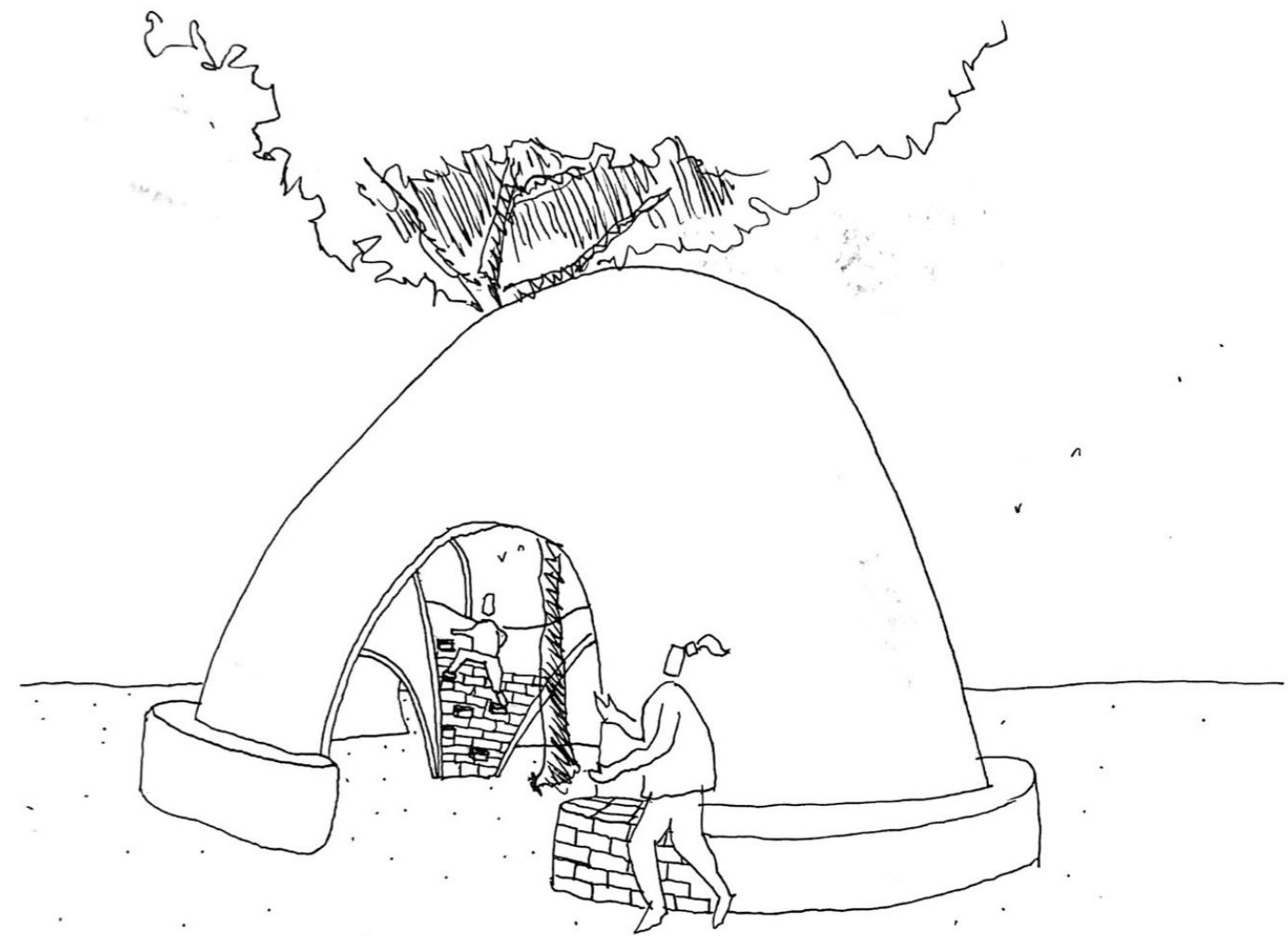
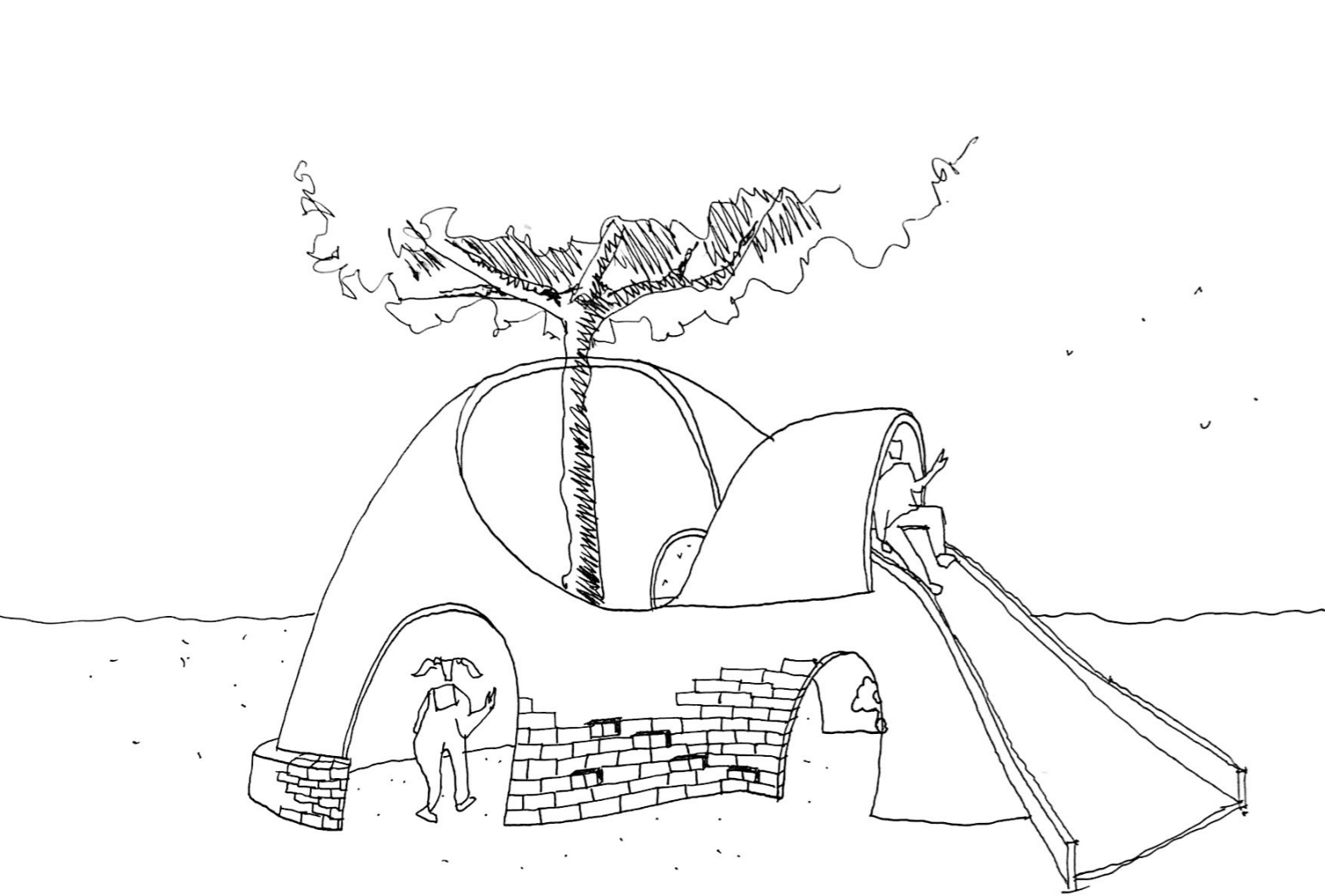

Calpinage

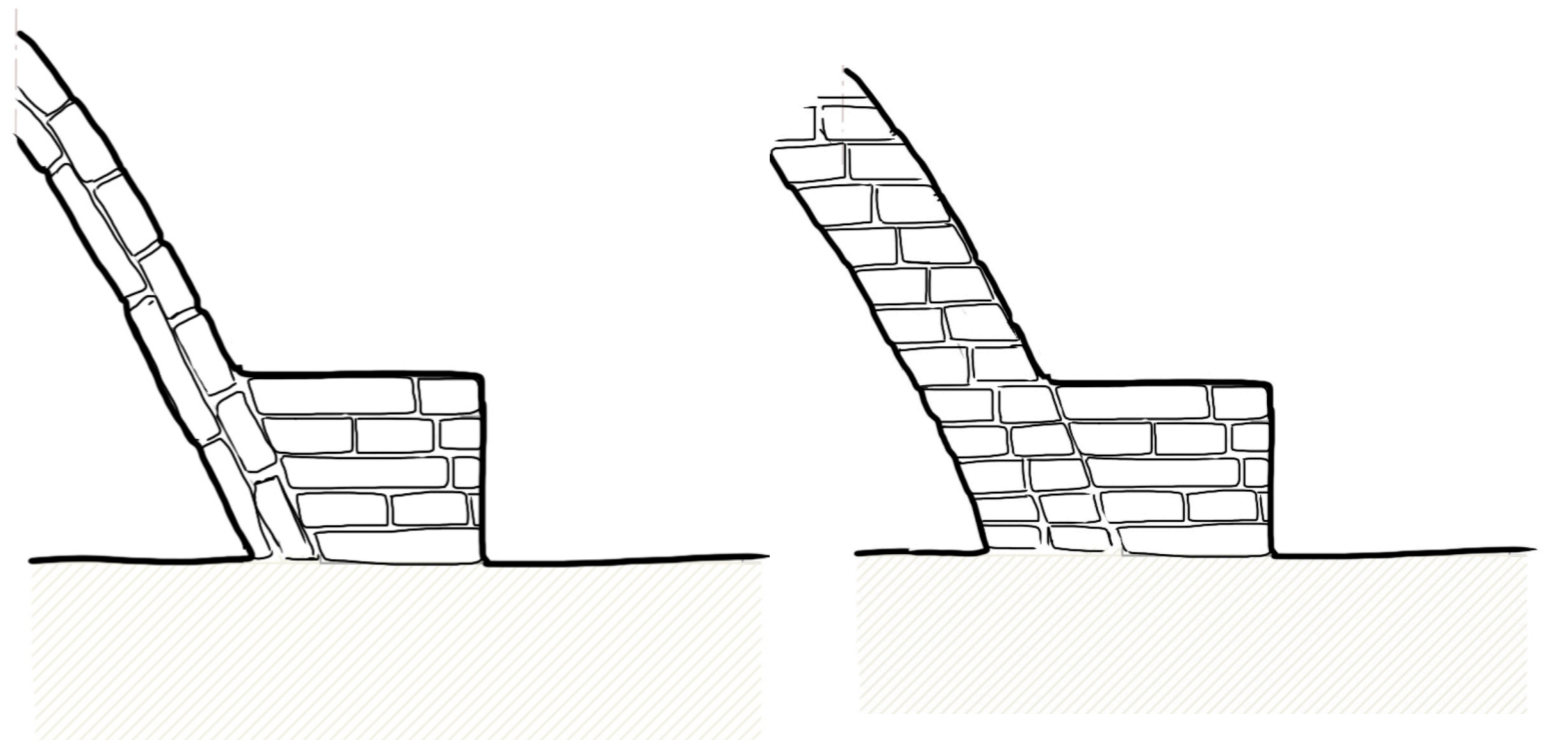
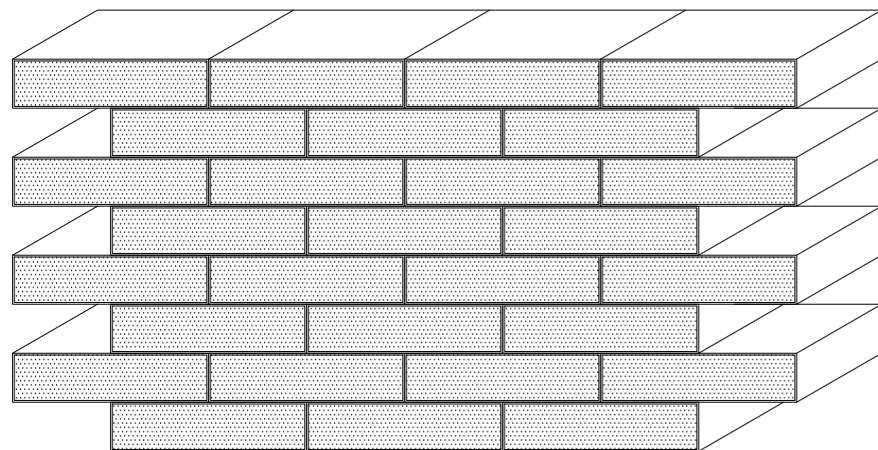
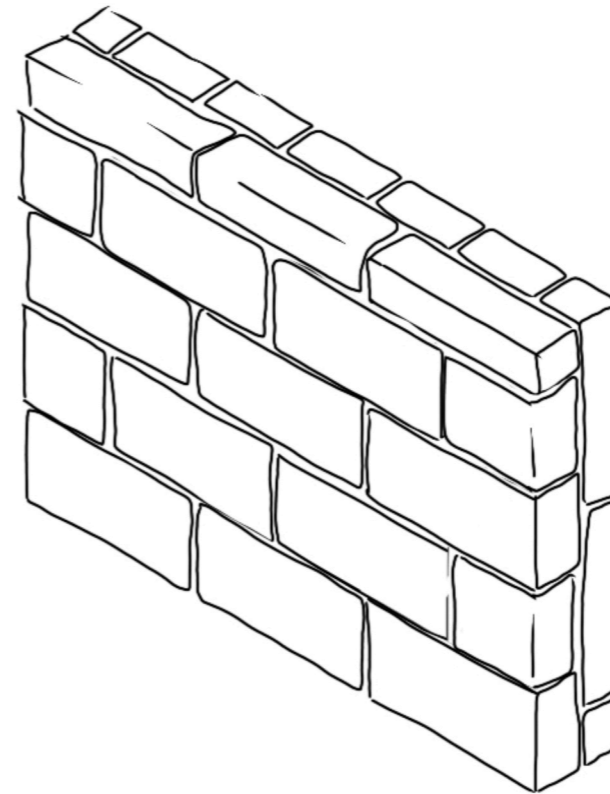
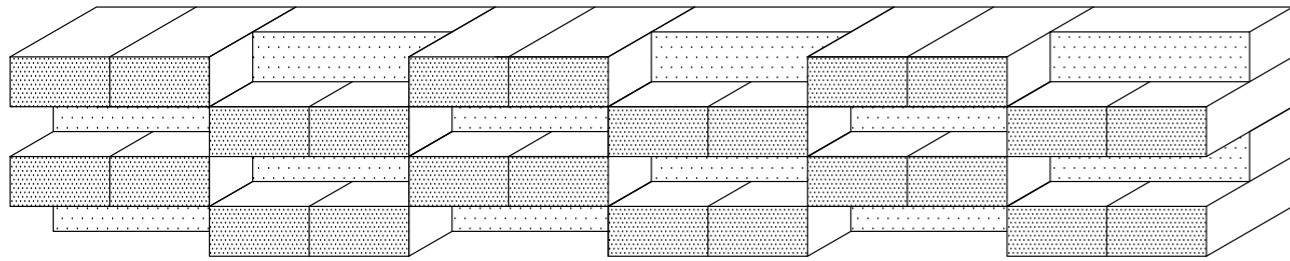
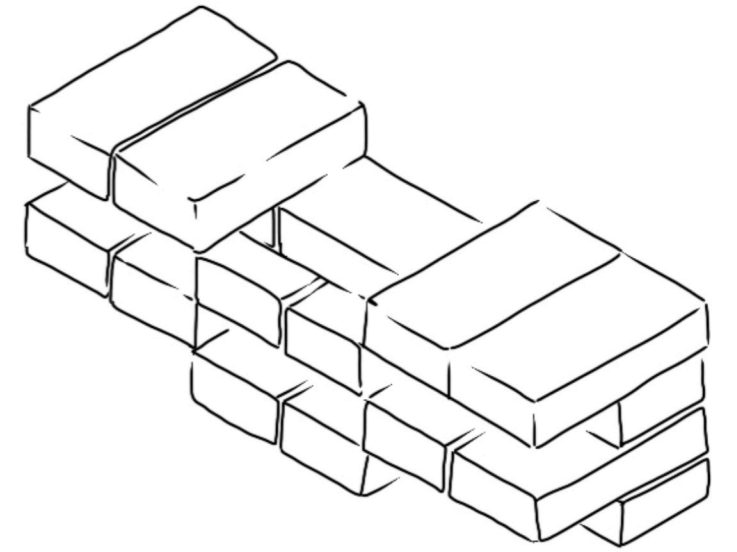

Eintrage

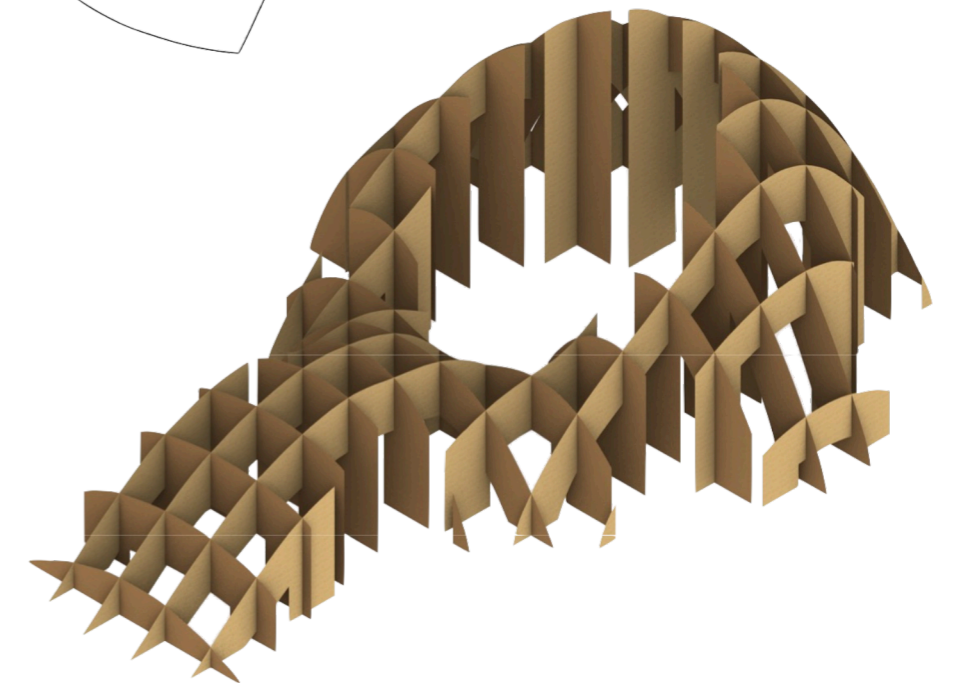
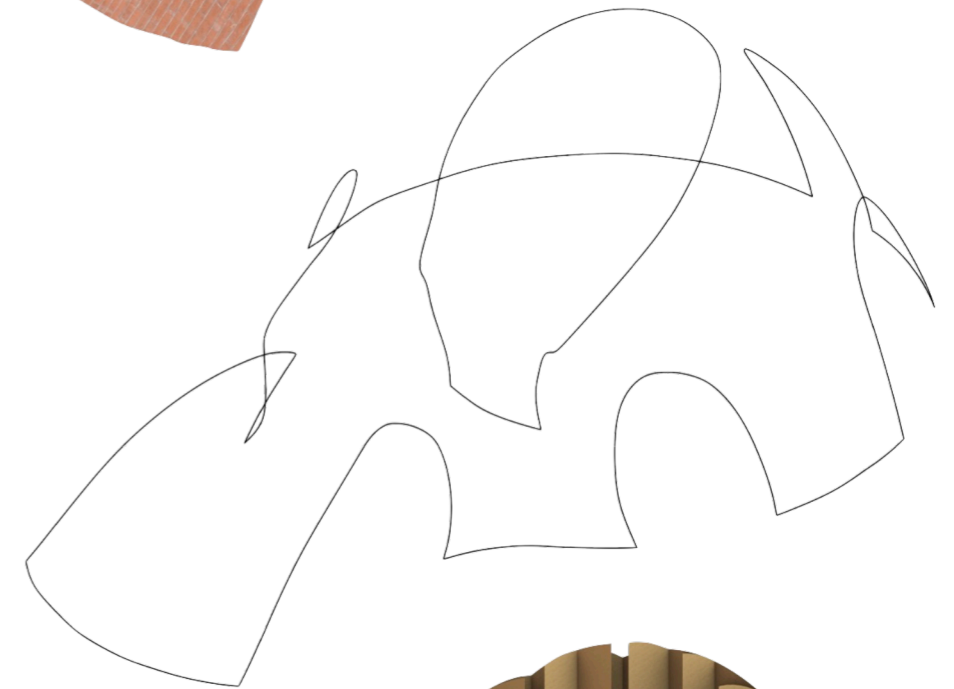
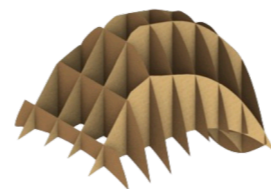
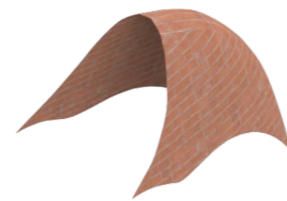
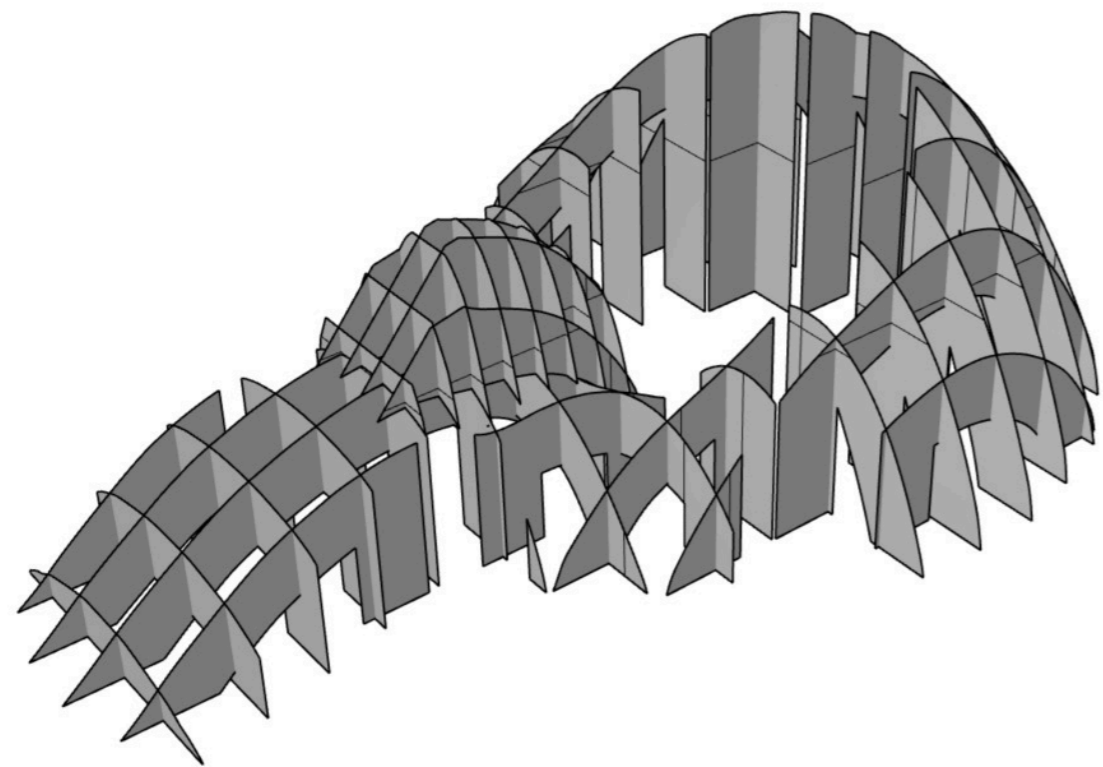

Arthur Jasmin
Lou Soler
Flora Otal
Louise Trano
Müge Senkal
Simon Achard
Marion Ajalbert
Charlotte Serain
Gabriel Villalobos
Guillaume Pacquement
Guillermo Arevalo Aucahuasi



Merci à Marc Leyral pour ce suivi et cet enseignement...